

# X-Ray Computed Tomography Scanning for Defense Applications



**Ryan Peitsch**  
National Technical Services -  
Chesapeake

February 2019

DSIAC is a DoD Information Analysis Center (IAC) sponsored by the Defense Technical Information Center (DTIC) with policy oversight provided by the Office of the Under Secretary of Defense (OUSD) for Research and Engineering (R&E). DSIAC is operated by the SURVICE Engineering Company



# Basic Process of CT Scanning: Overview

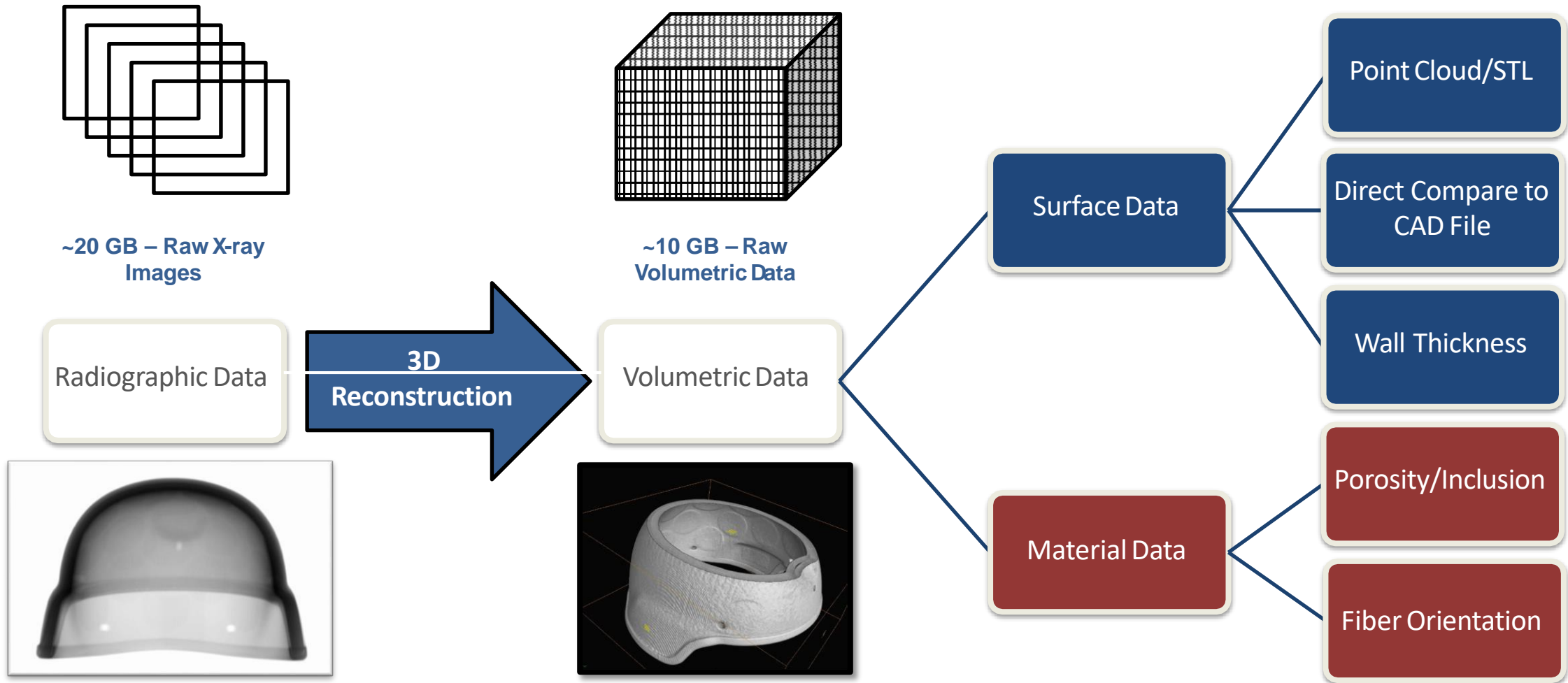

# Applications of Industrial CT Scanning

## Research & Development

### Material Analysis

- Fiber Orientation
- Porosity

### Geometric Analysis

### V&V of Models

## Reverse Engineering & Prototyping

### CAD Surface Extraction

- Point Cloud/STL
- NURBS Surface Model
- Full-Featured CAD (SW/ProE)

## Manufacturing & Quality Control

### Product Acceptance & Qualification

### First Article Testing

- Wall Thickness
- CAD Comparison
- GD&T

### Failure Analysis/DOE

## Lifecycle Management

### Failure Analysis & Investigation

### Reverse Engineering

- Obsolescence/ Legacy Components



# NTS Chesapeake Non-Destructive Testing Facilities

- **225/450-kV microfocus CT scanner**
  - 36-inch working envelope
  - PerkinElmer 1620
  - + custom-built LDA
  - 450-kV max resolution: 70  $\mu\text{m}$
  - 225-kV max resolution: 2  $\mu\text{m}$
- **225/320-kV microfocus CT scanner**
  - PerkinElmer 1621ES enhanced sensitivity
  - Imaging panel
  - 20 fps cine-radiography video
  - 320-kV max resolution: 30  $\mu\text{m}$
  - 225-kV max resolution: 2  $\mu\text{m}$

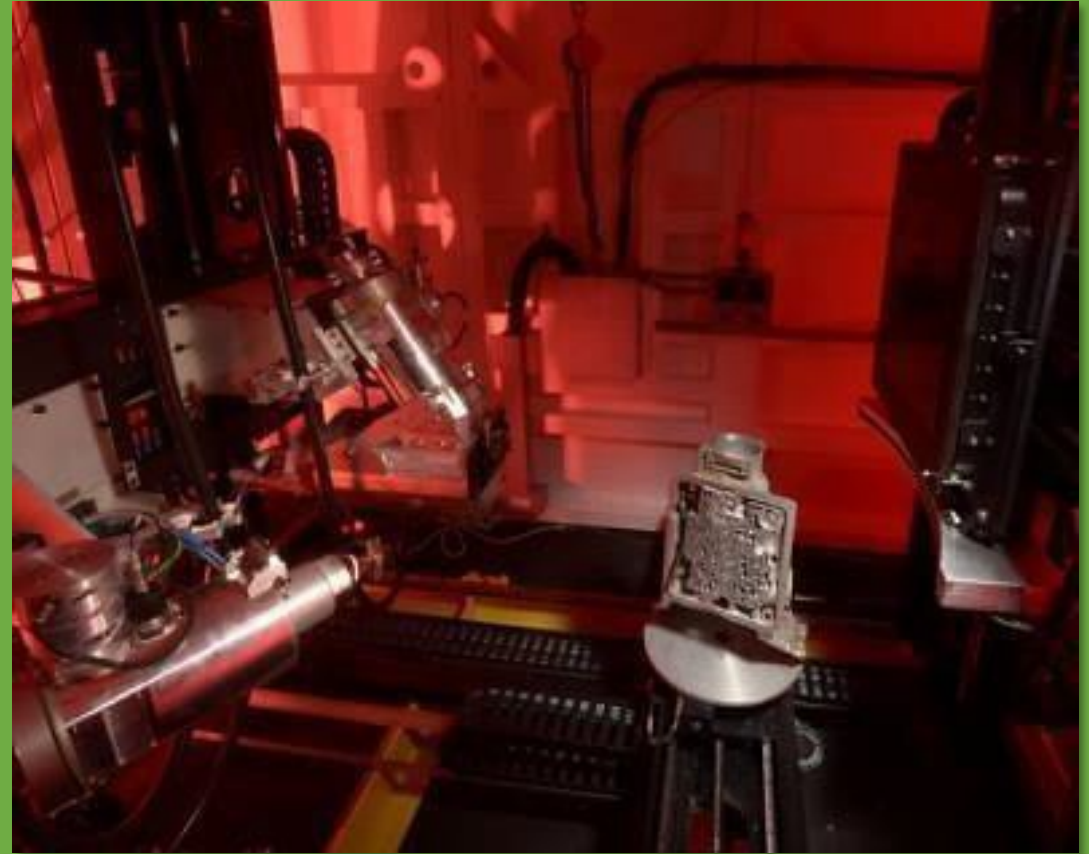

450-kV micro-focus CT scanner inside walk-in bay

# Major Programs in XCT NDT

- **U.S. Department of Defense**
  - Various branches/agencies – armor, firearms, ammunition, materials research
- **National Transportation Safety Board (NTSB)**
  - Investigation support
  - 787 Dreamliner batteries
- **NASA (Johnson/Langley)**
  - Materials research/batteries
- **Smithsonian Institution**
  - Paleontology – marine mammals
  - Digitization Program Office

## New Knowledge From Ancient Specimens Using X-Ray Computed Tomography (CT)

Case Studies, Computed tomography, Metrology CT, X-ray and CT Inspection

The Smithsonian's Natural History Museum together with Chesapeake Testing consulting firm are using computed tomography (micro CT) to not only scan marine mammal fossils, but also make 3D scans and data available for knowledge-seekers around the world.

The mission of the Smithsonian Institution, the world's largest museum and research complex, is admirably brief: "The increase and diffusion of knowledge." The vision statement, a bit longer, is no less cogent: "Shaping the future by preserving our heritage, discovering new knowledge, and sharing our resources with the world." Within those statements is a commitment to finding and using the most effective tools to accomplish these ideals. The following describes how the Smithsonian's Natural History Museum together with an engineering consulting firm known mainly for ballistics and armor testing are using X-ray computed tomography (micro CT) to not only scan marine mammal fossils, but also make 3D scans and all the data they contain available for knowledge-seekers around the world.

## CHESAPEAKE TESTING ASSISTING THE NTSB USING ADVANCED X-RAY COMPUTED TOMOGRAPHY TO INSPECT BATTERY UNITS AND COMPONENTS

JANUARY 30, 2013

January 30th, 2013

For Immediate Release – Belcamp, MD

The National Transportation Safety Board (NTSB) has announced the award of a service contract to Chesapeake Testing to provide non-destructive testing in support of an investigation.

Citing Chesapeake Testing's close proximity to Washington D.C, its unique technical qualifications, and the ability to quickly respond to the required timeframe for this requirement, the NTSB is sending lithium ion-type battery cells to Chesapeake Testing for x-ray computed tomography (CT) scanning.

DSIAC





# X-Ray CT Applications



# Ballistics: Hard Armor Plate (SiC/B4C)

*Quantify post-test damage and evaluate multihit, hard-armor plates*

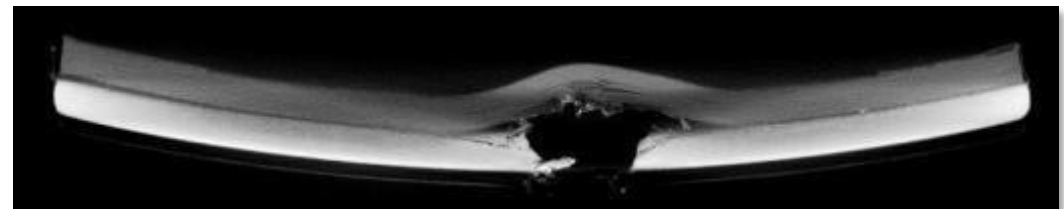
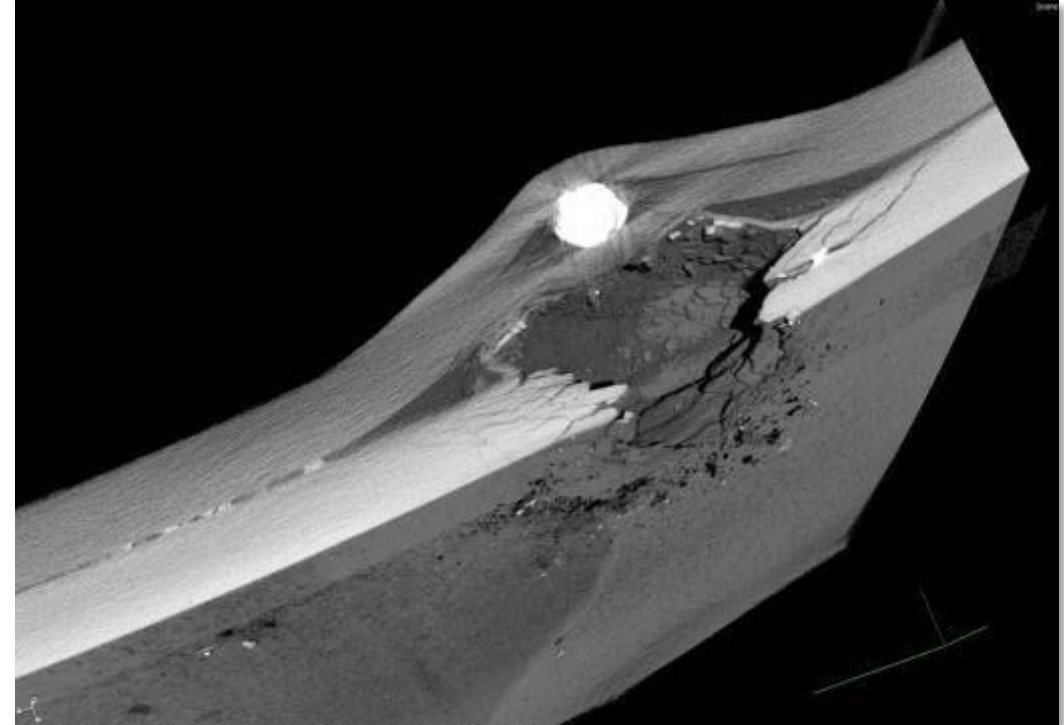

# Ballistics: Handgun Testing/Failure Analysis

## Beretta M9 9 mm

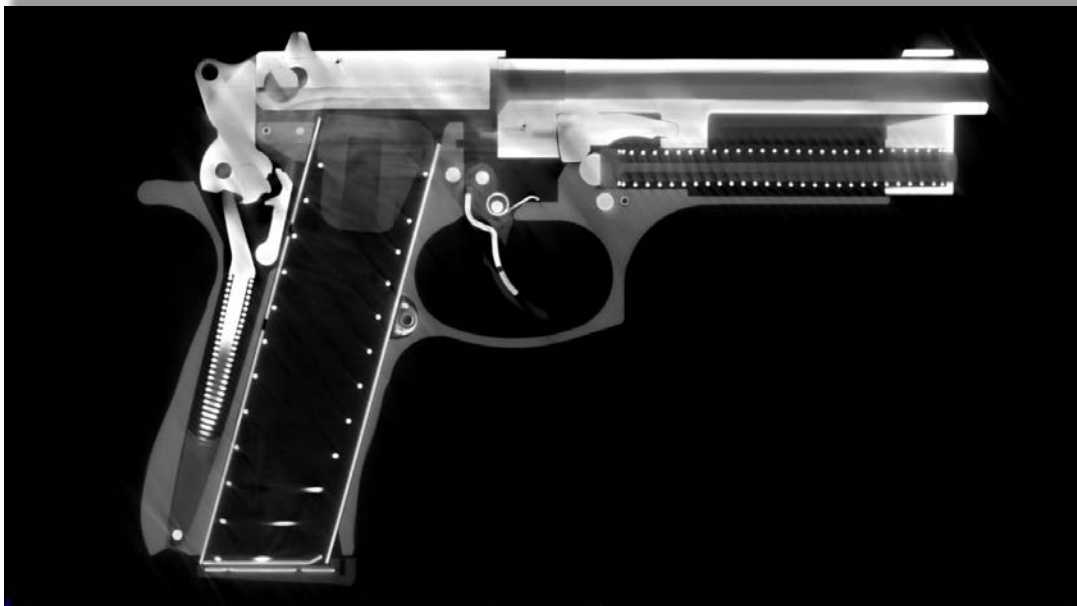



# Ballistics/Munitions

- Ammunition
  - Locate/quantify:
    - Core shape
    - Core volume
    - Propellant fill
    - Propellant volume
    - Incendiary fill
    - Incendiary volume

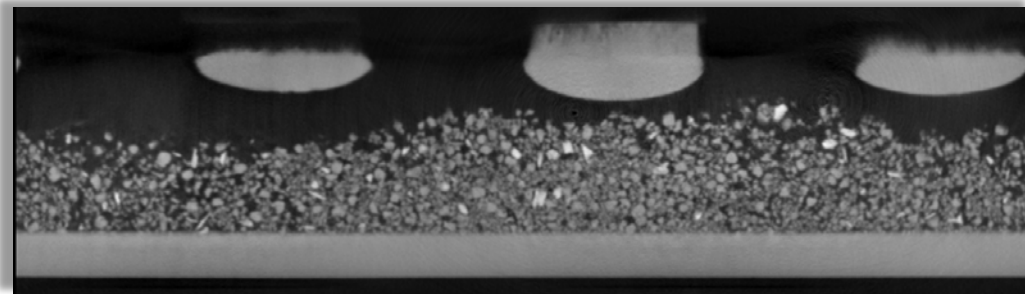
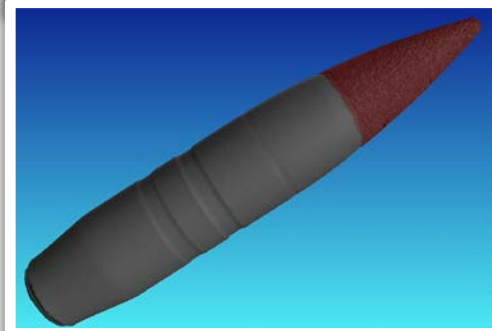
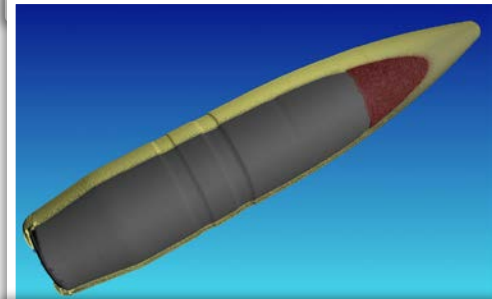
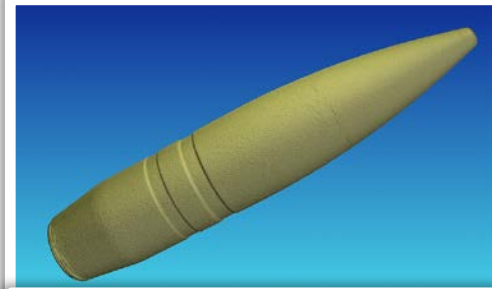
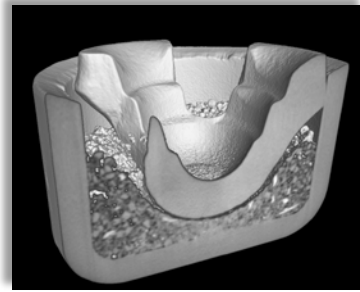
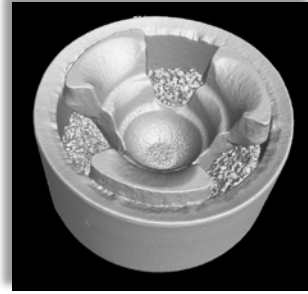

Unroll view of a primer

# Composites: Truss Structure/Failure Analysis

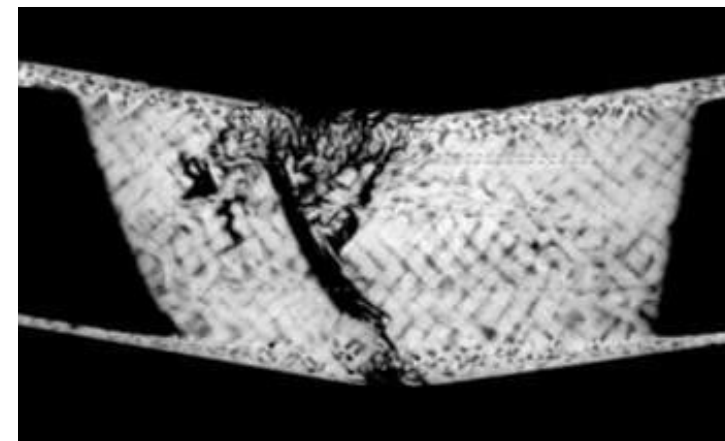
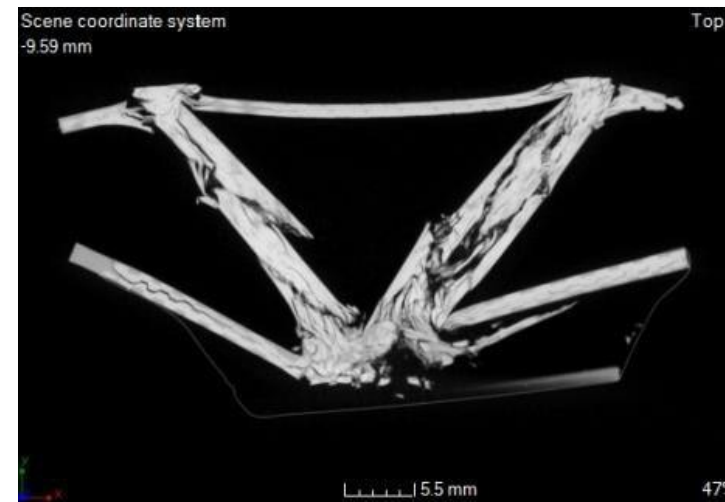
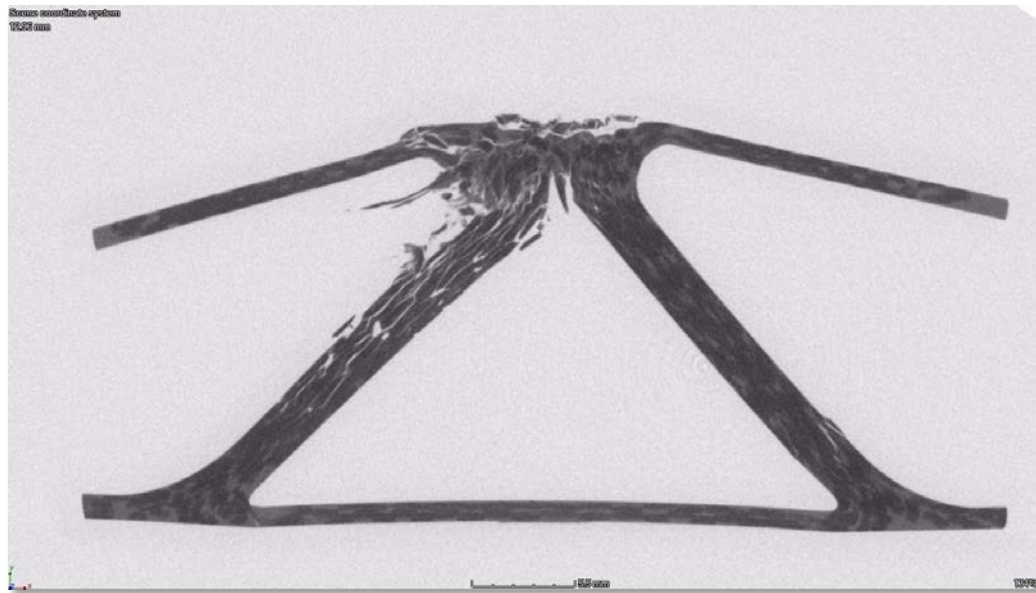
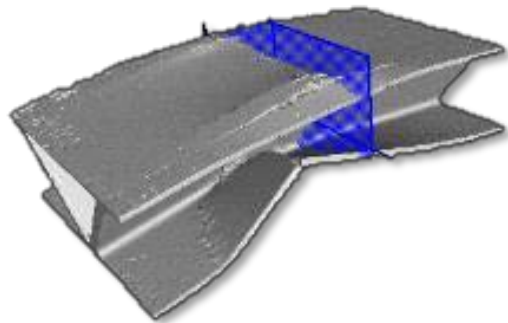

# Composites: Void Analysis, Fiber Orientation

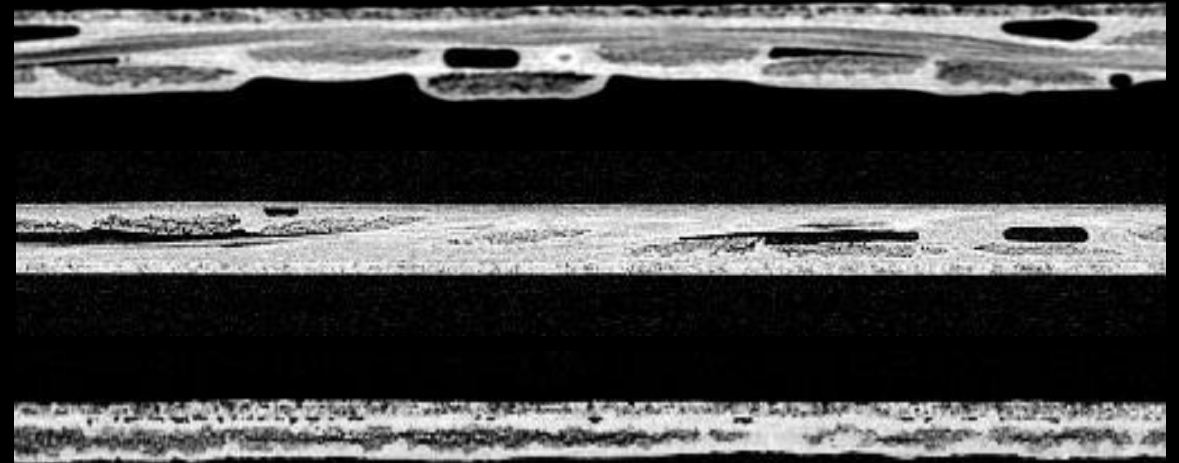
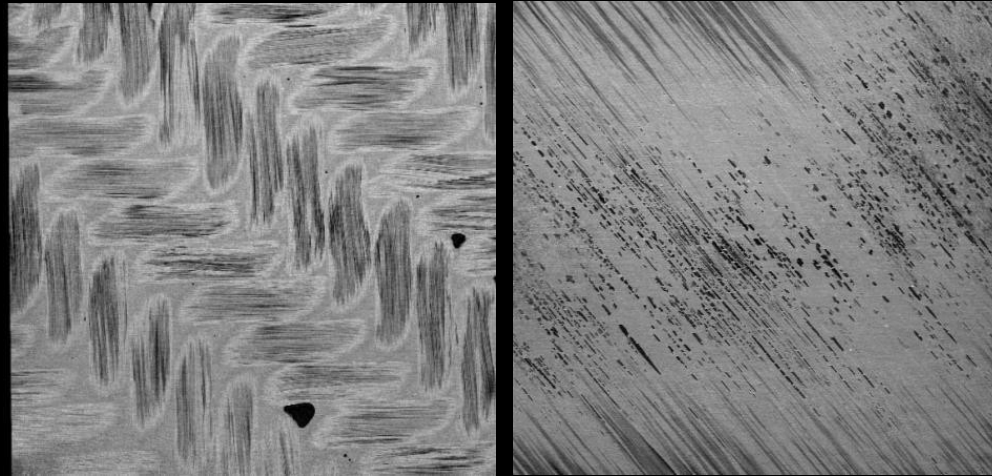
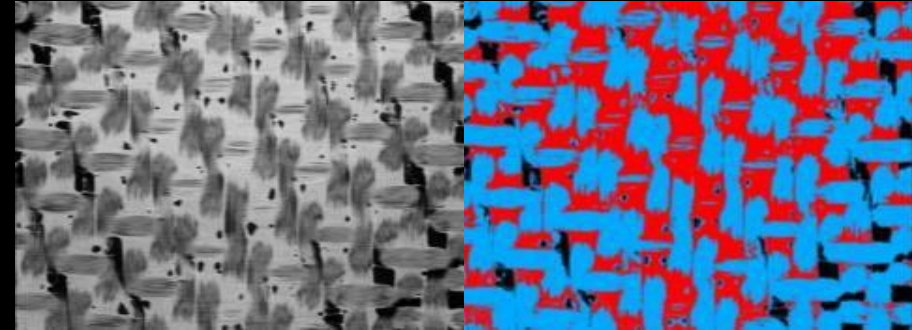
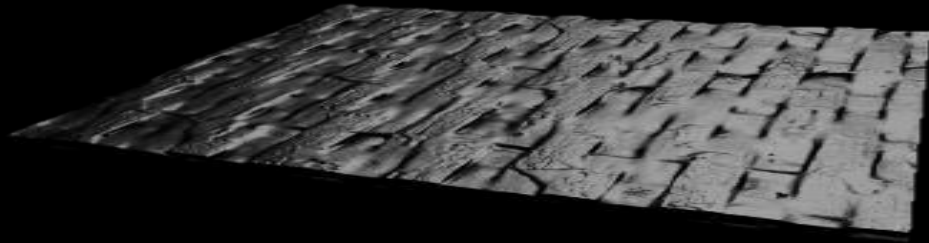



# Composites: Void Analysis, Fiber Orientation (cont.)

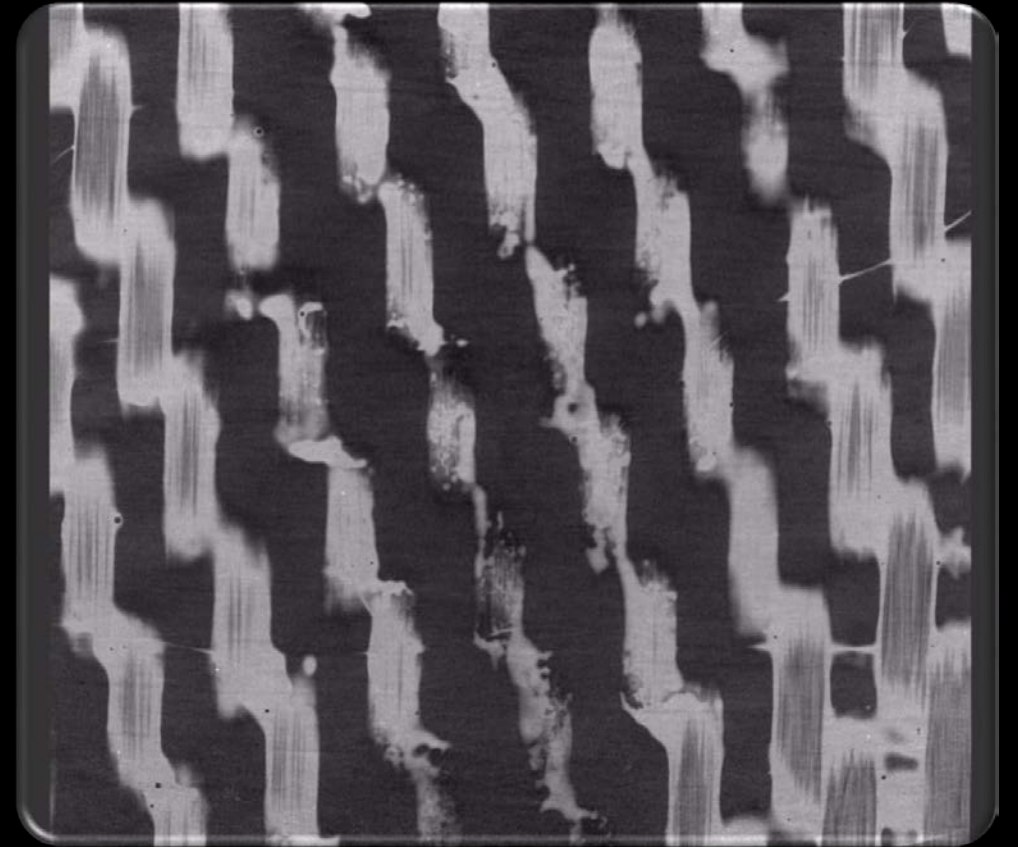
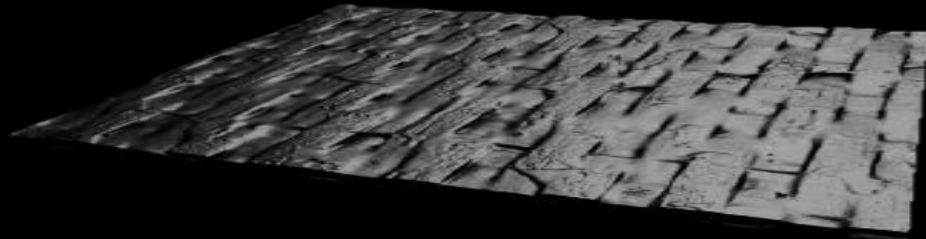

# Composites: Woven Fiber Analysis

Analyze 3D weave structures, fiber integrity, needle damage, fiber orientation

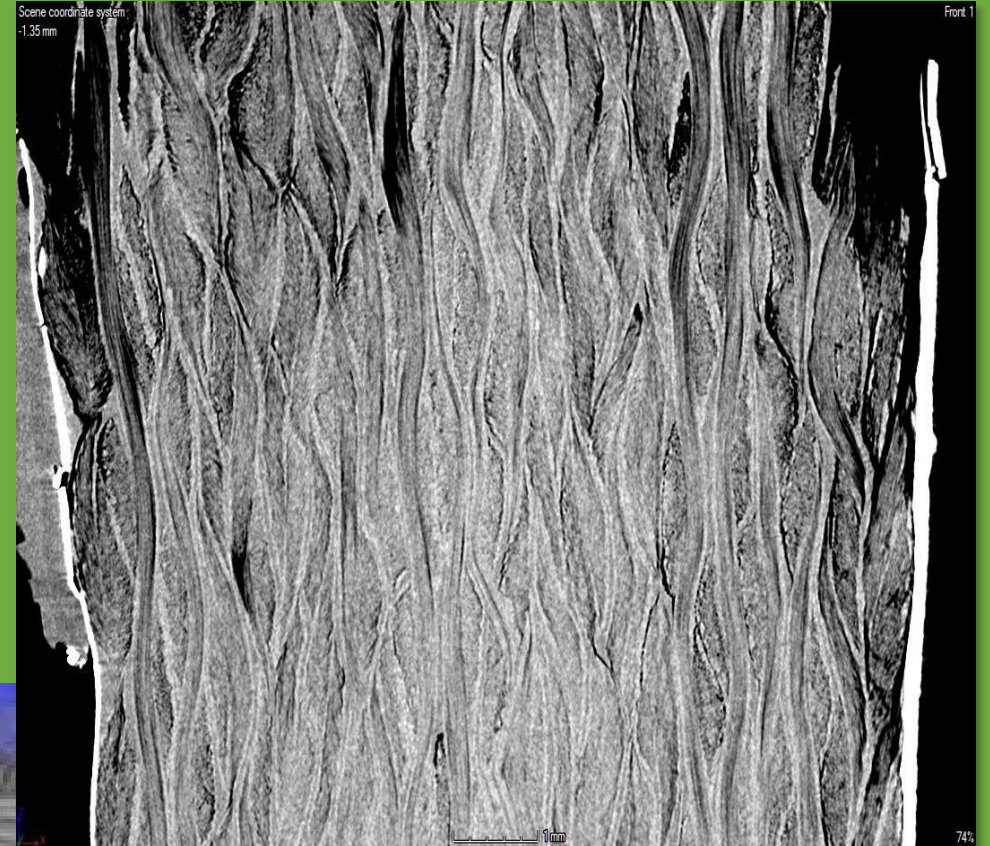
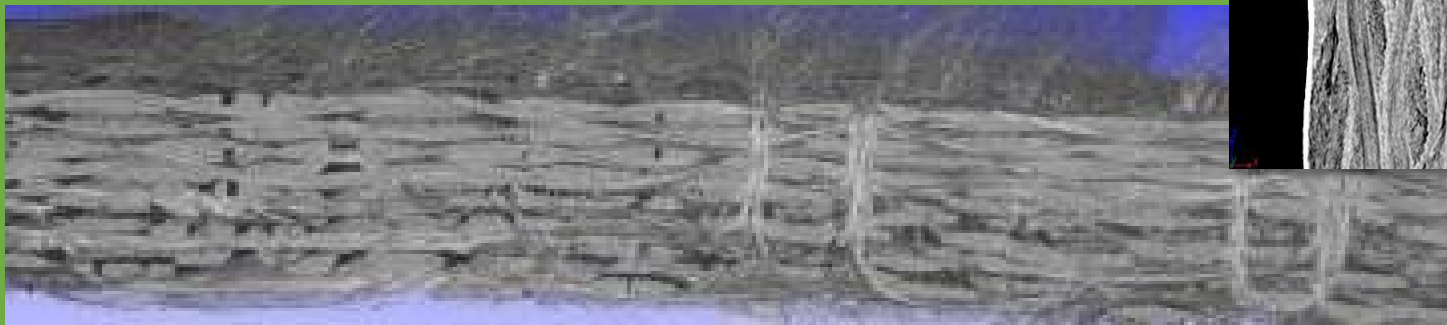
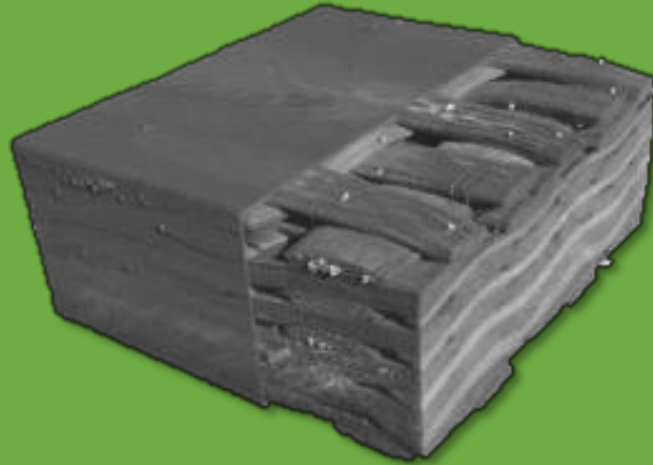

# Composites: Carbon Fiber Bicycle Frame

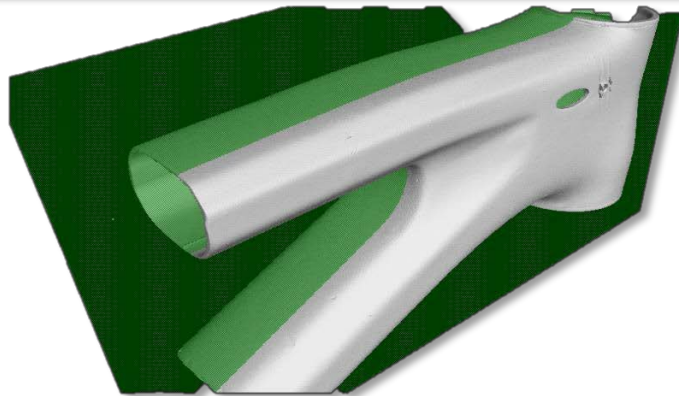
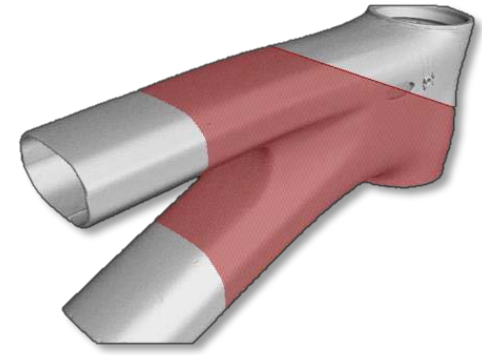



# 3D Printing/Additive Manufacturing

## Quality Control, Reverse Engineering

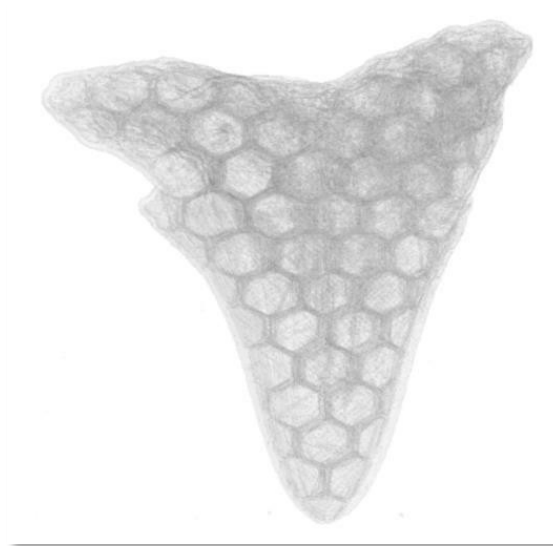
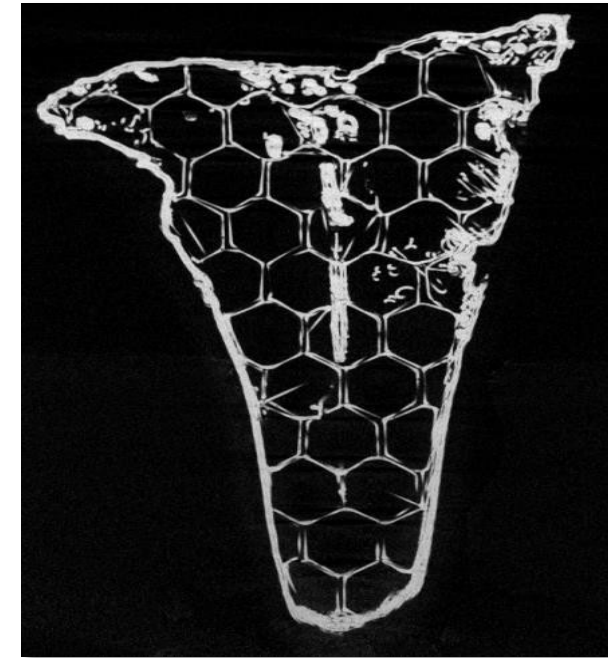
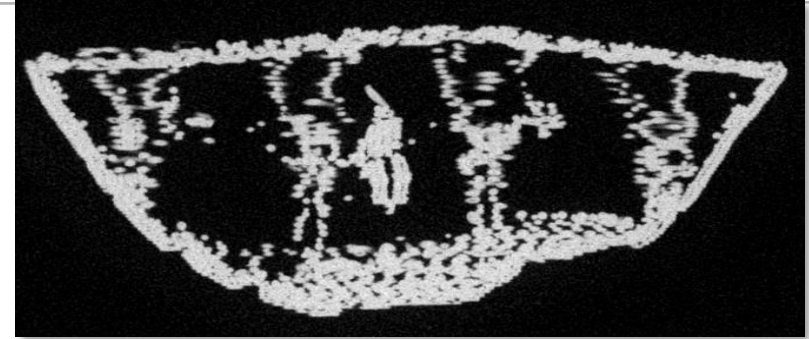
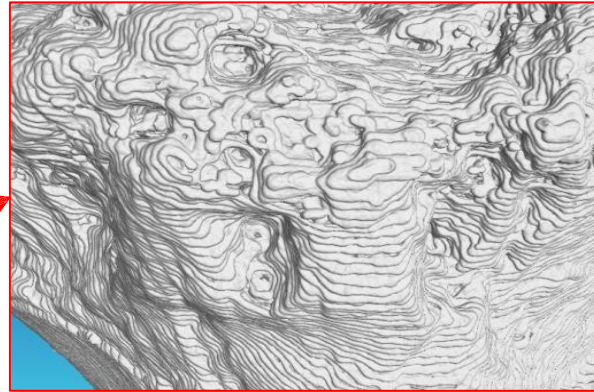
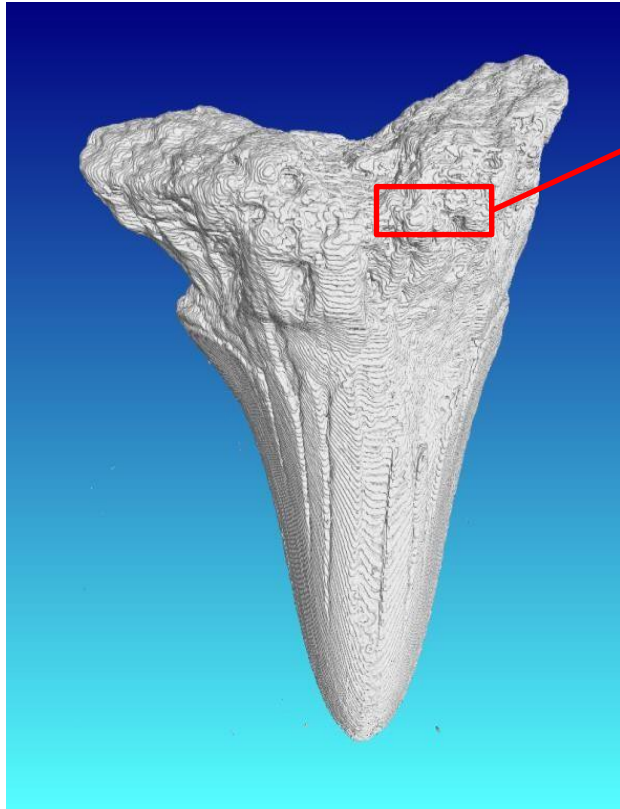

DSIAC

# Electronics: Lithium-ion Battery Cells

- Obtain resolution and contrast to resolve electrodes in roll
- Evaluate extent of damage
  - Thermal damage, deformations, puncture, etc.
- 100% non-destructive
- Ability to receive, store, and test live cells

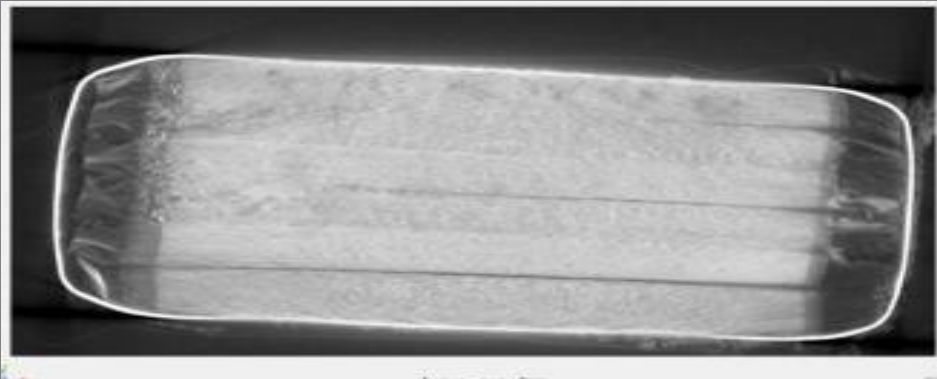

2013-2014: Chesapeake Testing awarded a sole-source contract by the NTSB for urgent non-destructive testing in support of the investigation of lithium-ion battery units.

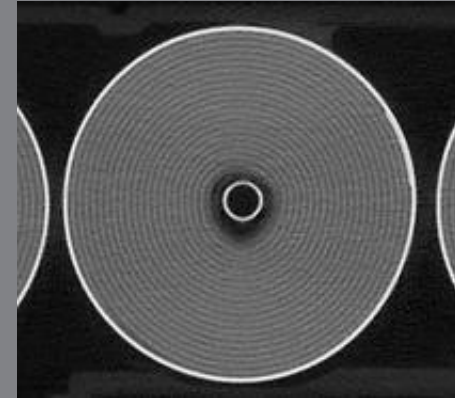

Left: image from the NTSB Interim Factual Report, dated 7 March 2013

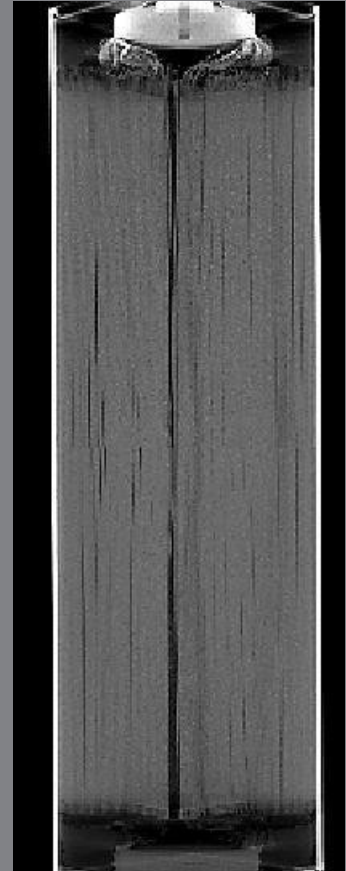

# Electronics: Lithium-ion Battery Cells

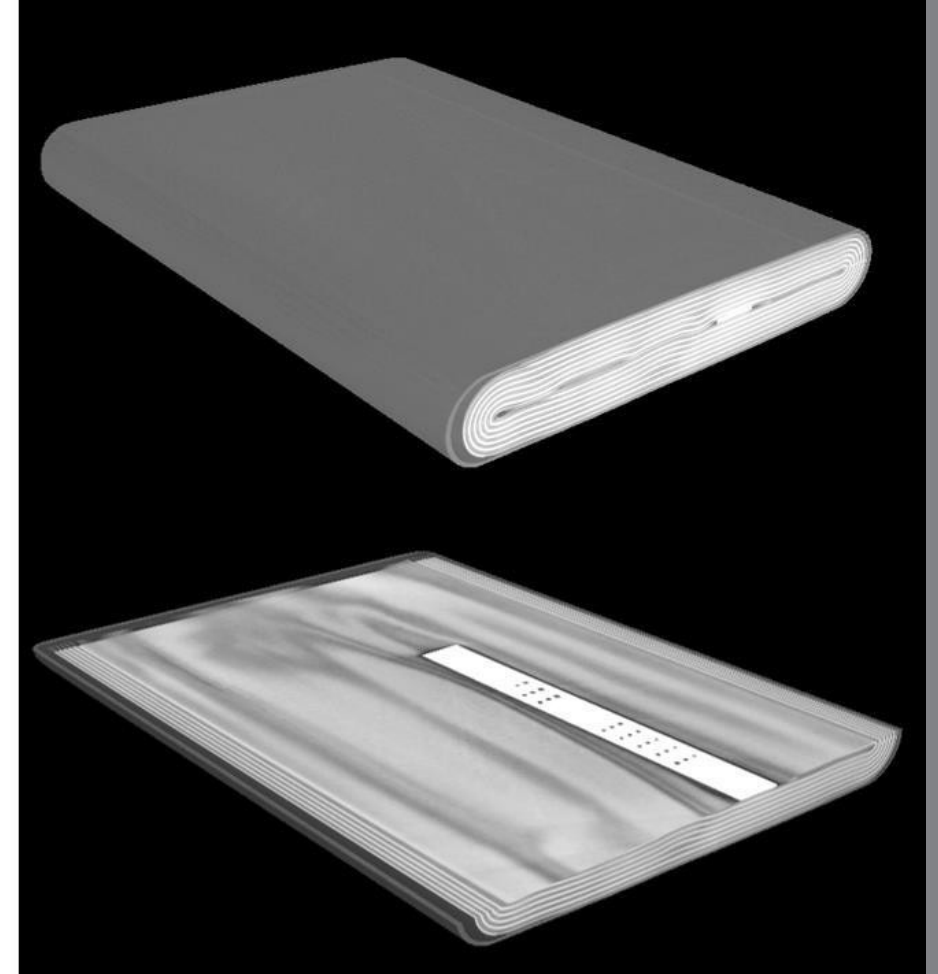
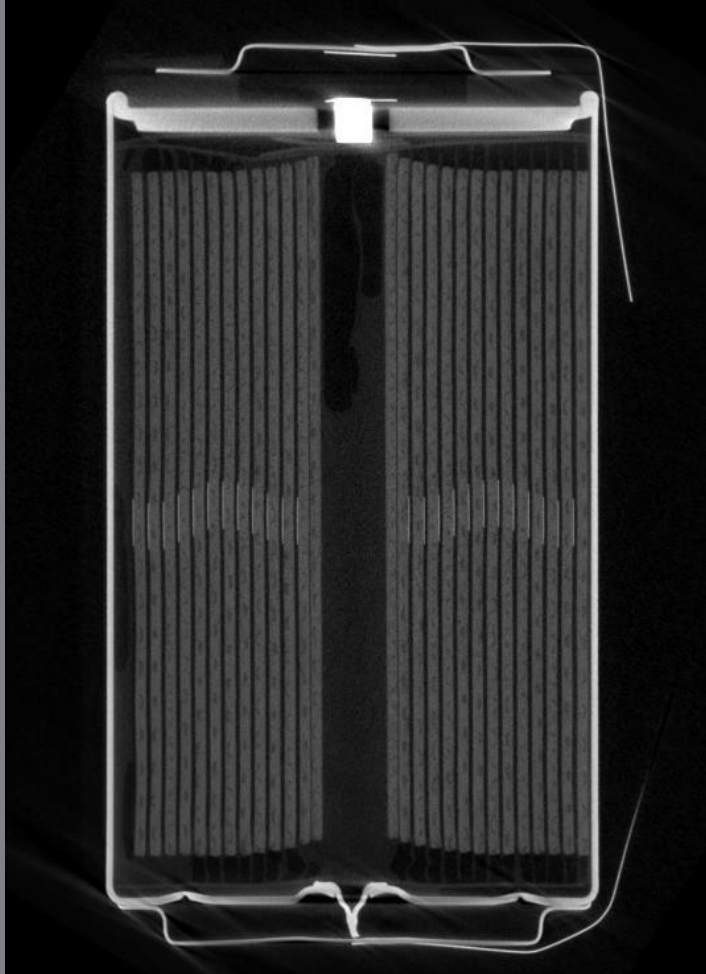



# Electronics: Solder Fill & Quality

Obtain virtual cross sections to evaluate areas of high/low solder fill & effectively troubleshoot intermittent shorts/opens

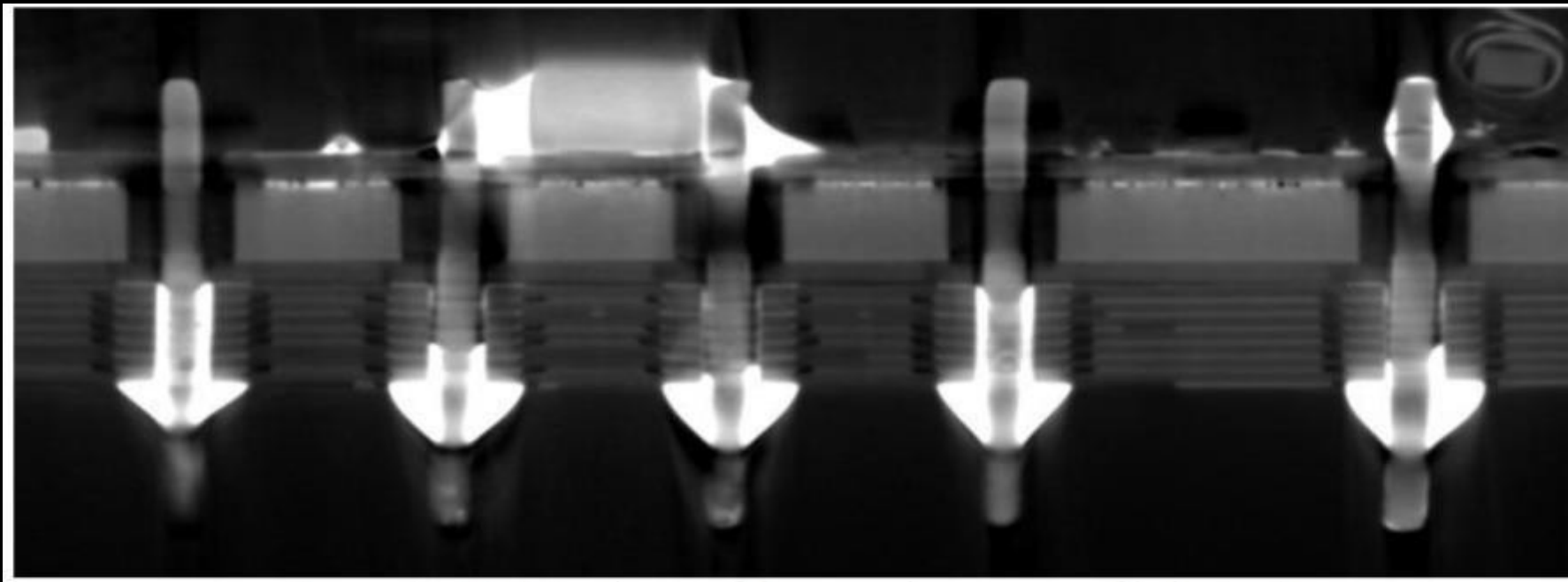
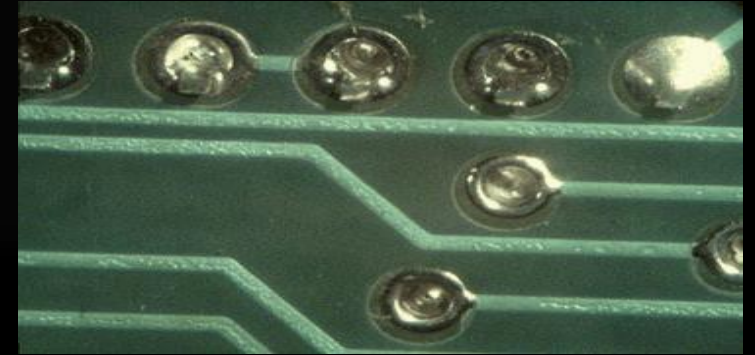

# Electronics: Wire/Board Connectors

- Troubleshoot connections
- Assess mating quality under different stress/strain conditions
- Evaluate complex connectors

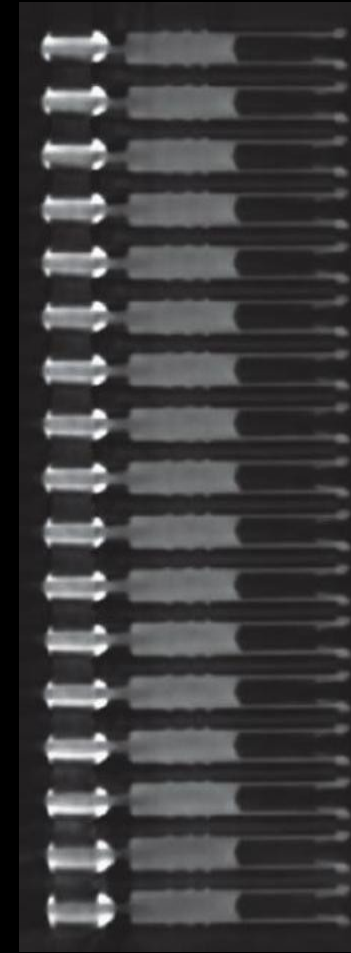
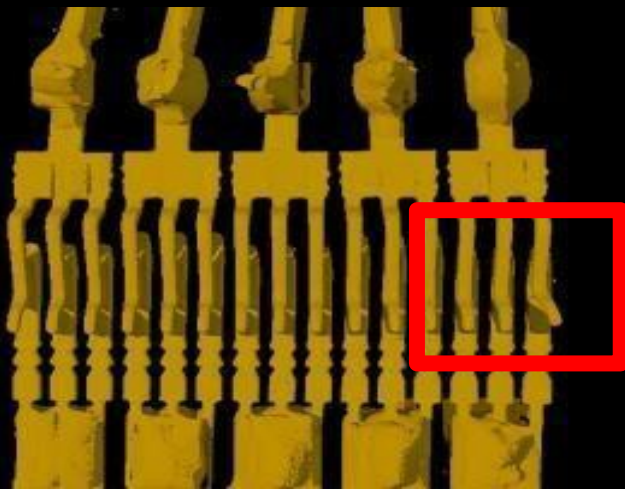
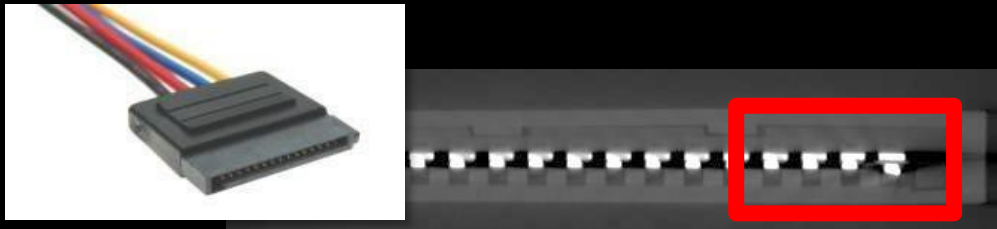

# Internal/Hidden Surface Metrology

## Geometric Dimensioning & Tolerancing, Part-to-CAD

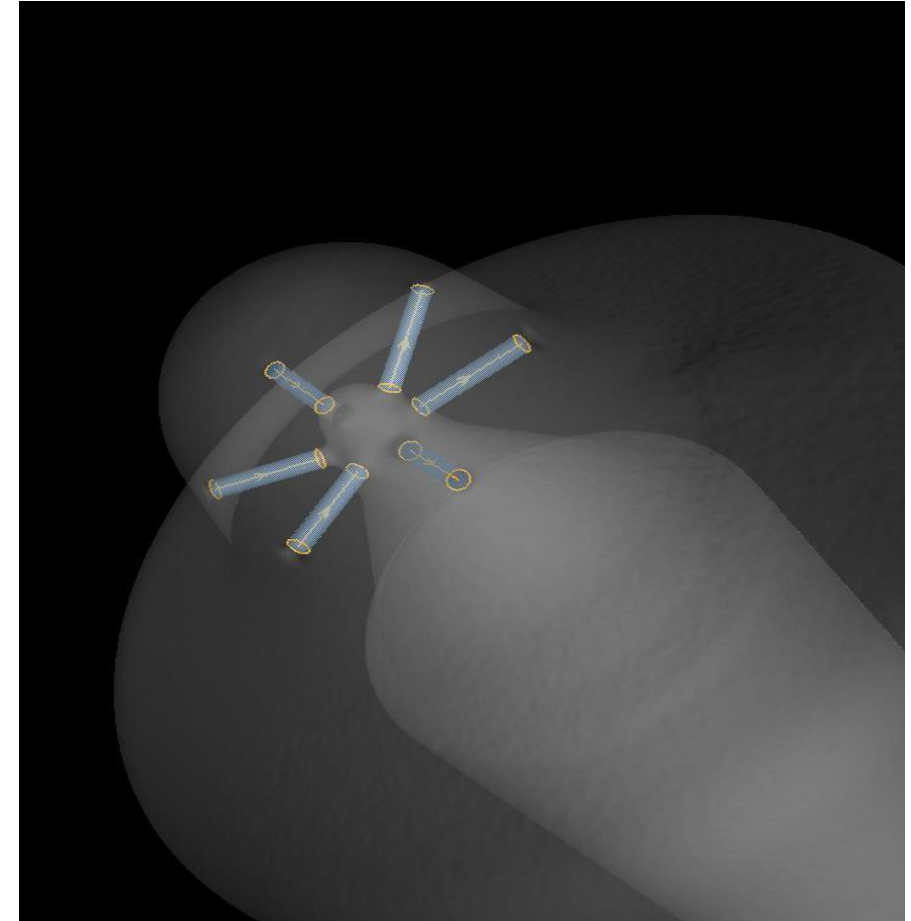
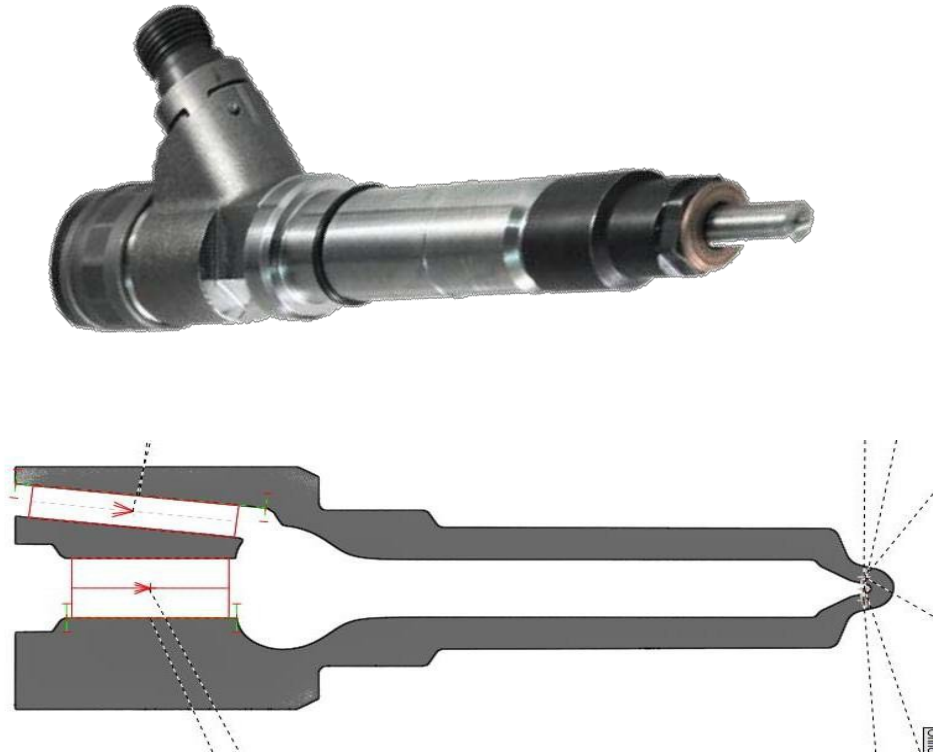



# Other Applications

## Metrology/Reverse Engineering

- **Generate surface geometries from complex-shaped parts**
  - Faceplates, bezels, connectors, etc.
- **All geometries captured in single acquisition – no stitching of multiple scans**
  - Reduces time, cost, error
- **Output formats include:**
  - Point Cloud
  - Polygon (STL)
  - IGES
  - STEP
  - Full-featured CAD (SolidWorks, ProE)

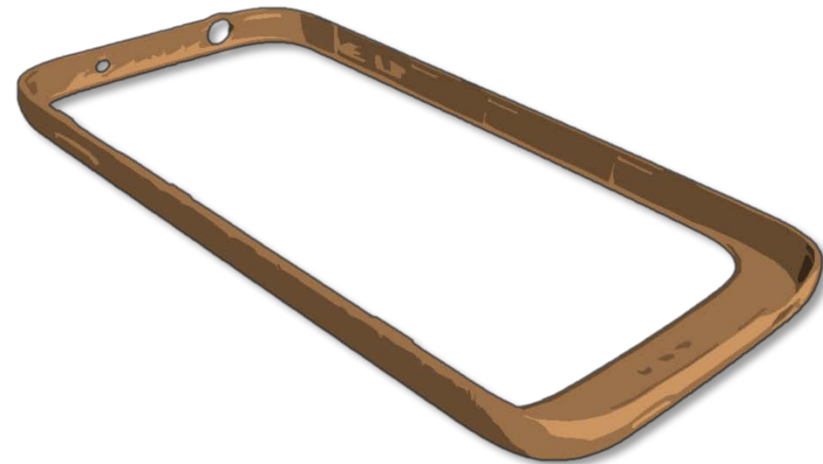
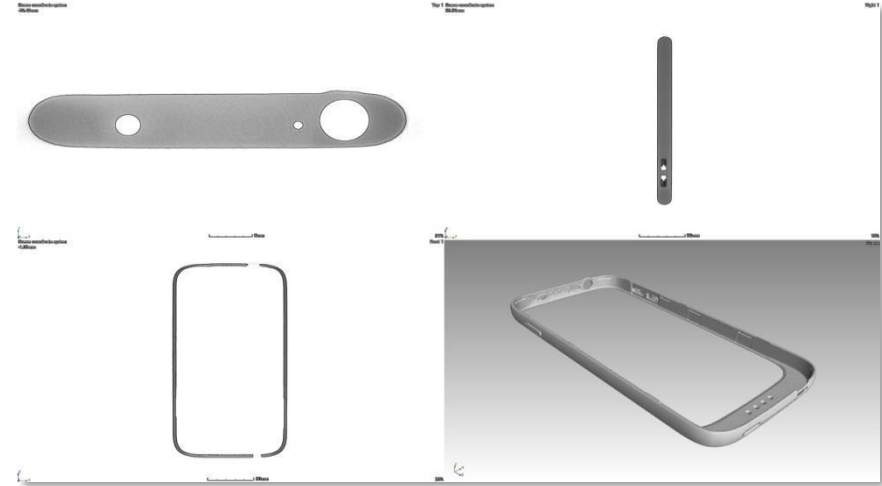

# Other Applications

## Metrology/Reverse Engineering



Obsolete component used  
to create TDP for re-  
manufacture

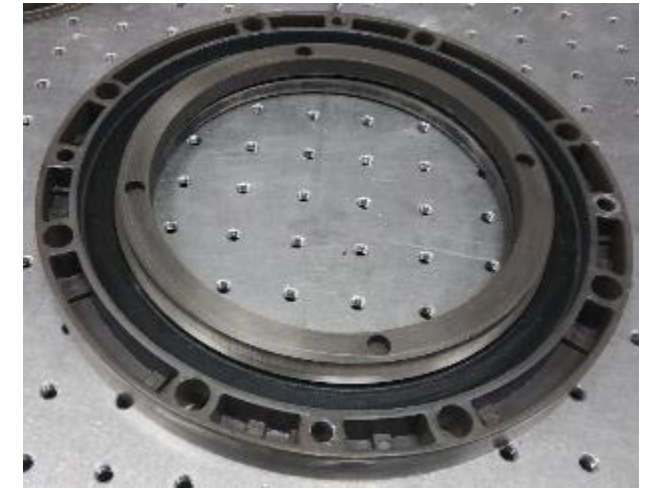

Scan mesh with XCT  
scanner

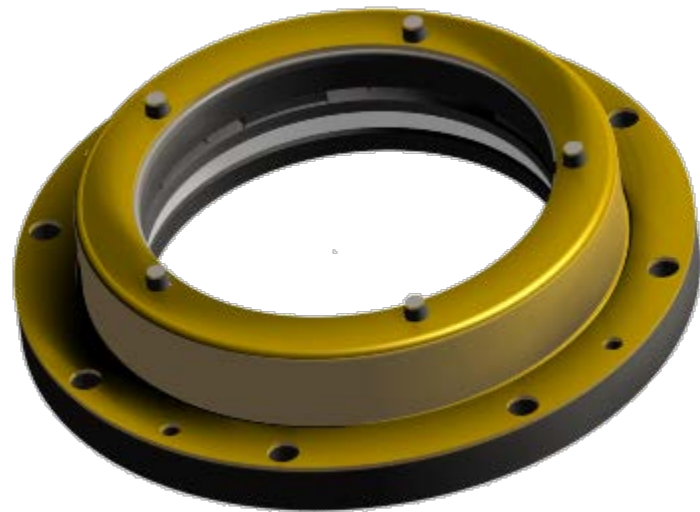



# Conservation/Artifacts: Boxwood Prayer Beads

## 100% Non-destructive Analysis



3D Model Generated From Scan Data



# Conservation/Artifacts: Smithsonian Fossils

*Waipatia maerewhenua*, an archaic Late Oligocene dolphin (~26 million years old)

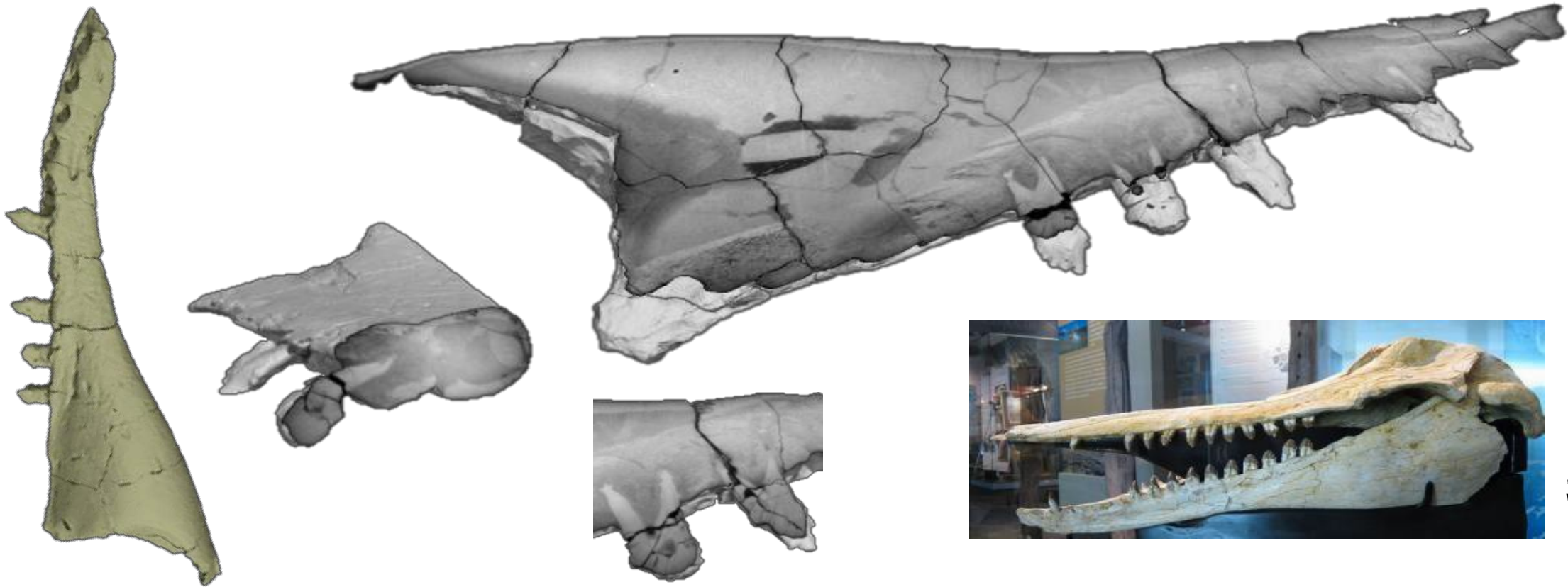

Smithsonian  
Institution

DSIAC



# Contact Information

---

**Ryan Peitsch**  
NTS Chesapeake  
Non-Destructive Testing Division



**[Ryan.Peitsch@nts.com](mailto:Ryan.Peitsch@nts.com)**

**(410) 297-8154**

**DSIAC**

